



PIPE TOOLS & VISES
SINCE 1896



TM1100



Direct Tapping Machine User Manual Manual del operador para aterrajaz

DIRECT TAPPING MACHINE - TM1100

Applies to: 09300, 09304, 09314, 09323

COMBINATION TAPPING & DRILLING MACHINE - CDTM1100, CDTM2100

WARNING:

Read and fully understand all instructions before operating any of Reed's tapping or drilling machines. Failure to follow all instructions listed inside, may result in serious personnel injury and / or property damage.

CONTENTS:

- 1) Basic Product Information
- 2) Operating Instructions
- 3) Maintenance Instructions
- 4) Parts Illustration, Parts List, and Necessary Accessories

TAPPING MACHINE - TM1100 COMBINATION TAPPING & DRILLING MACHINE - CDTM1100, CDTM2100

Basic Product Information:

The TM1100 Direct Tapping Machine drills and taps pressurized water mains. The tool additionally installs a 3/4" or 1" corporation stops. The tool can drill and tap 4"-48" cast or ductile iron and C-900 PVC. The base tool requires saddles for specific sizes and chain extensions above 16". The tool uses Reed DT series drill taps.

Additional Specifications

- Tool Box overall outside dimensions:
TM1100 27 x 5/8 x 13 3/4 X 14
See sketch for overall machine dimensions.
- Machine Clearance radius:
TM1100 = 32"
- Pressure Rating: Design pressure rating for valve and chamber = 250 psi.
- Operating Pressure Rating - 90 psi - ie - Drilling or Tapping into pressurized mains.

Catalog No.	Item Code	Size	Pipe Dia	Net Shipping Wt
TM1100	09300	3/4" - 1"	4"-48" TAP	114 lbs./52 kg
CDTM1100	09304	3/4" - 1" TAP & DRILL	4"-48" TAP	114 lbs/52 kg
CDTM2100	09314	3/4" - 1" TAP/ 2" DRILL	4"-48" TAP	116 lbs/53 kg

Warning:

Drilling or Tapping into highly pressurized mains is not recommended. However, it is permissible at pressure up to 250 psi, if utilizing special precautions and incorporating high pressure attachments such as the Mueller® Power Clevis #H-10800. (See operations and maintenance manual.) DO NOT USE on natural gas or petroleum piping.

- Flushing/blow by port: 1/2-14 NPT plugged port is provided in bottom chamber for flushing chips while tapping into pressurized mains.
- Swing check valve resists clogging and is easy to clean out.
- Manual pressure balancing and top chamber pressure relief valves are accessible and easy to use.
- Manual or power drive operation through 13/16" square shaft (Adapter sold separately).

Materials and Finish:

- Hard anodized and powder epoxy painted aluminum frames.
- Alloy steel boring bar.
- Heavy duty steel chain and forged steel chain hooks.
- Bronze and zinc aluminum parts.
- EPR rubber gaskets and "O" rings.
- Plated steel parts.

TM1100 Operating Instructions:

Warning:

The maximum operating pressure for this tool is 90 psig (621kPa). When using a power clevis, the maximum operating pressure is 250 psig (1724 kPa). DO NOT USE this tool on pipes containing natural gas or petroleum products.

Warning: Dry tap a piece of pipe to acquaint personnel with the machine and to preset groove depth for tapping.

- Select proper tools necessary to perform tap.**
 - Corporation stop.
 - Drill tap size to match corporation stop threads.
 - Proper size saddle.
 - Proper size corp insertion tool.
 - Any other necessary accessories to meet operating requirements.

- Assemble chamber to the pipe.**

- Clean area of pipe where tap will occur. Use a REED DS12 or DS36 Descaler.
- Place bottom gasket into the tapping saddle before placing saddle on the pipe.
- Place tapping saddle on the top of the pipe with the tabs/ears of the saddle parallel with the length of the pipe.
- Place disc gasket on the top recess area of the saddle.
- Unscrew the top cap (assembled with Boring Bar).
- Place the machine chamber onto the disc gasket recess. Position the machine so the swing valve is on the same side as the operator.



- Place chain hooks and swivels into slots on both sides of the chamber.
- Connect the chain to one of the chain hooks, bring chain under the pipe and connect on the other side to the nearest link. Do not twist or create kinks in the chain.
- Hand tighten nuts.

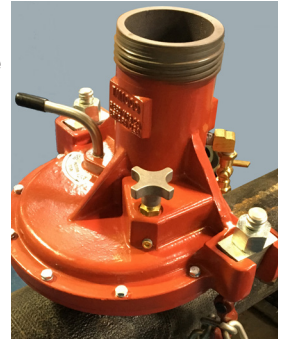

NOTE:

Use additional chain extensions and clevis for diameters over 16".

- Position chamber at desired angle between 45° and 90° from vertical.**

- Tighten down chain nuts **EVENLY**, using REED CW12 Adjustable Wrench or L2017 Dual Socket Ratchet Wrench.
- Ensure the gaskets make good contact.
 - Verify chain holds the machine securely on the pipe and saddle.

- Insert Drill Tap into Boring Bar.**

- Push knockout pin in Boring Bar to its holding position. (Toward flat side of bearing)
- Insert shank end of drill tap and align pin with slots in bar end.

NOTE: Make sure inside taper of the boring bar is clean before inserting the drill tap.

- Make sure drill tap is securely seated and lightly tighten the tool retaining screw.

NOTE: Do not over tighten the retaining screw that holds the drill tap. Over tightening can strip out the threads.



- Retract tool end of Boring Bar all the way into the top cap.

- E. Generously coat tap with REED Tapping Compound #98425 or #99140.
NOTE: Always use clean drill taps coated with tapping compound. Fully clean drill tap threads with wire brush between taps and reapply tapping compound.

5. Assemble top and bottom halves

- A. Verify:
a. Swing valve open.
b. Upper ball valve shut.
c. Needle valve (silver star knob) shut, clockwise.
B. Screw Boring Bar top cap hand tight onto the top chamber (1 3/4 Turns).
C. Push down Boring Bar slowly until bit touches the pipe.
D. Adjust the Star Feed as necessary. Place the Yoke over the bearing.
E. Put ratchet wrench on top of Boring Bar.

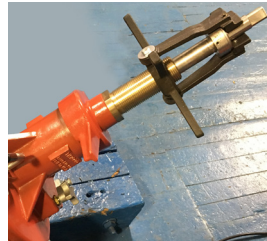

6. Drilling and Tapping

- A. Preparing to Drill
a. **Manually:** Adjust the ratchet wrench to turn clockwise.
OR
b. **Power Drive:** Reed Power Drive Adapter #98427, 700PDTMPDA #05276 or 601PDTAP #05246. The operator can control the feed rate for drilling.
B. Drill through the pipe by pulling the ratchet wrench clockwise and turning the star feed clockwise in a smooth and consistent manner. An easily turning Boring Bar and star feed indicates one has completed drilling through the pipe wall.

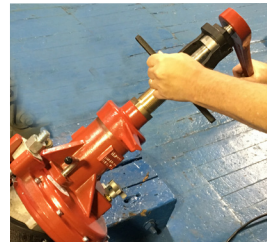

Manual Use



Power Drive Use

- NOTE:** Do not overfeed the drill taps, let the bits do the cutting before feeding. Turn the drill tap one full revolution by hand before feeding.
C. If appropriate, open the ball valve to allow flushing of chips while drilling.
D. Feed drill tap down until feeling resistance. One will feel resistance when the tapping threads contact the pipe wall.
E. Begin tapping by rotating the ratchet wrench with star feed swing clamp engaged.
F. Continuously turn the feed housing, slow enough to allow the drill tap threads to feed. Rotate in a smooth and constant manner. **DO NOT FORCE** the star feed. Forcing the star feed will strip off the threads. After two full turns of drill tap into pipe, remove swing clamp of star feed and continue tapping.
G. Continue tapping until start of the 3/32" wide groove (Depth Stop Line) in the Boring Bar sits flush with the Main Body. This depth should result in

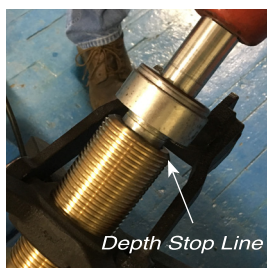

Depth Stop Line

a satisfactory tap. Resharpener drill taps may require two additional turns. Other manufacturer's drill taps may vary. Consult drill tap manufacturer's instructions. Consider conducting dry taps to determine a depth that works best for you.

NOTES:

- Pay attention to the Depth Stop Line on the boring bar to keep from cutting too deep.
- Weight of a power drive could possibly affect downward pressure when tapping the pipe, especially on PVC.

7. Drill Tap Removal

- A. Reverse the ratchet detent lever (or Power Drive Switch) and carefully back the drill tap out of the tapped hole using a counterclockwise rotation.

- B. Once the drill tap is free of the pipe, retract the Boring Bar to its uppermost position.

CAUTION: If pipe is pressurized, apply resisting force to allow boring bar to slowly retract.

- C. Close the swing valve by pushing down on the handle and turning it 90 degrees counter-clockwise.

- D. Open the pressure relief valve on the top chamber to release pressure, then close it again.

- E. Unscrew the top cap assembly from the valve chamber.

- F. Loosen the tool retaining screw and strike the end of the knockout pin to release the drill tap.

8. Attaching Corporation Stop to Boring Bar

- A. Verify the selected corp stop matches the size intended and the drill tap size.

- B. Verify the corporation stop is in closed/off position.

- C. Screw the corp stop and corp adapter together.



Shown with Reed HAM3 (not included).

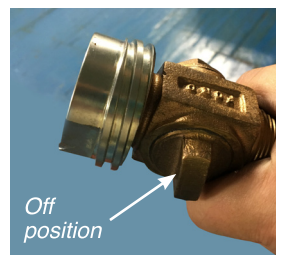

Off position

- D. Screw the adapter shank to the corp adapter.



- E. Push knockout pin in Boring Bar to its holding position. (Toward flat side of bearing sleeve.)



- F. Insert tapered end of the adapter shank into the Boring Bar and align the pin with the slots in the bar end. Tighten, but do not overtighten, the tool retaining screw.



- G. Make sure the Boring Bar retracts all the way into the top cap. Apply non-toxic pipe dope to corp inlet threads.

- H. Screw assembly into the valve chamber.

9. Inserting the Corp Stop

- A. Attach the ratchet wrench onto the Boring Bar and set it for clockwise rotation.



- B. Turn the star knob counter-clockwise 1 turn to balance the pressure.

- C. Push down on the swing valve handle and turn 90 degrees clockwise.



- D. Push the Boring Bar down until the corp stop threads touch the pipe.
E. If not already done, swing Yoke over the Boring Bar to engage the bearing. Feed the bar as needed.



- F. To start the engagement, rotate the Boring Bar clockwise while carefully turning the feed housing clockwise. Once the threads are engaged, disengage the Yoke. Continue rotating until the corporation stop feels solid. Do not attempt to permanently tighten the corporation stop with the machine.

10. Releasing the Corporation Adapter

- A. Reverse the ratchet to turn counter clockwise.



- B. Remove play from the ratchet wrench with one hand, and strike the wrench handle with the other hand to disengage the corporation adapter from the adapter shank.



- C. Rotate the ratchet wrench counterclockwise until the adapter shank is completely free.

- D. Verify quality of corp stop seal by opening the chip flush valve and attempting to release pressure in the chamber. If pressure does not drop and water continues to flow, re-engage corp stop with the boring bar and attempt to tighten the corp stop further.

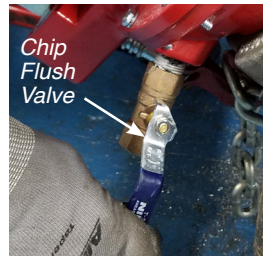

11. Machine Removal

- A. Unscrew top chamber assembly.
B. Loosen the chain hook nuts and unhook the chain. Remove hooks from the machine.



- C. Carefully remove the machine, saddle, and gaskets and place them on a clean surface.

- D. Tighten the corporation stop using a Smooth Jaw Wrench only on the corporation stop body. **DO NOT USE A PIPE WRENCH.**



- E. Remove the corp adapter using the REED RCORP wrench provided.



CDTM1100 and CDTM2100 Operating Instructions:

1. Drilling

A. Convert direct tapping set up to drilling set up.

- i. Remove 99307 Bearing Assembly by backing out the single set screw.
- ii. Remove the tapping boring bar from the 99300 Threaded Body
- iii. Insert the drilling machine boring bar into the threaded body.
 1. 3/4" and 1" branch taps - reinstall bearing assembly. Line the set screw up with the lower hole in the boring bar. Drive the screw in until recessing the screw slightly. (See figures 2 & 3)
 2. 1-1/2" and 2" branch taps -
 - a. Install 99301 Sleeve.
 - b. Reinstall bearing assembly. Line the set screw up with the lower hole in the boring bar. Drive the screw in until recessing the screw slightly. (See figures 2 & 3)
- c. Follow DM1100/DM2100 Operator's Manual #59305 to drill for service lines.

Choose

2. Tapping

A. Convert drilling set up to tapping set up.

- i. Remove 99307 Bearing Assembly. Back the single set screw out past the sleeve then remove the bearing assembly and sleeve.
- ii. Remove the drilling boring bar from the 99300 Threaded Body
- iii. Insert the tapping machine boring bar into the threaded body.
- iv. Reinstall the bearing assembly on the tapping bar.
- v. Line the set screw up with the lower hole in the boring bar. Drive the screw in until recessing the screw slightly.

B. Follow TM1100 Operator's Manual #59300 to direct tap service lines.

Maintenance Instructions: TM1100, CDTM1100, CDTM2100

Before Using

1. Clean and oil all bearing and wear surfaces and threads.
2. Inspect and clean tapping bits, and remove chips and scale. Chips and scale may prevent proper function of the tool.
3. Inspect and clean the Boring Bar tool end. Chips and scale may interfere with the insertion of the tapping bit or adapter shank.

After Using

1. Clean the machine and oil the machined surfaces. If necessary, the top and bottom chambers can be easily disassembled to clean more thoroughly.
2. Lubricate the tool holding area of the boring bar with REED #98425 Tapping Compound.
3. **Flush the bottom chamber** with a water hose to remove any chips. DO NOT hammer frames to remove chips or debris - Handle Carefully!
4. Protect threaded pieces by assembling them with their mating parts.
5. Periodically, inspect the Boring Bar's o-ring seals and replace if worn.
6. Carefully, place the tool back in the toolbox for storage.

PACKING the KIT



Figure 1

Line up notch with set screw—to prevent pilot drill from twisting when drilling.

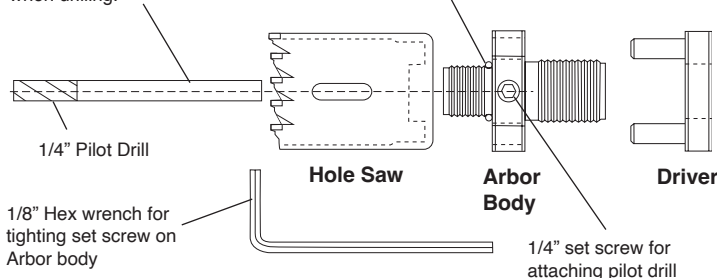

Note: When drilling PVC pipe, use PL shell cutters and no pilot drill.

Figure 2

Ready to drill
1" or 3/4"

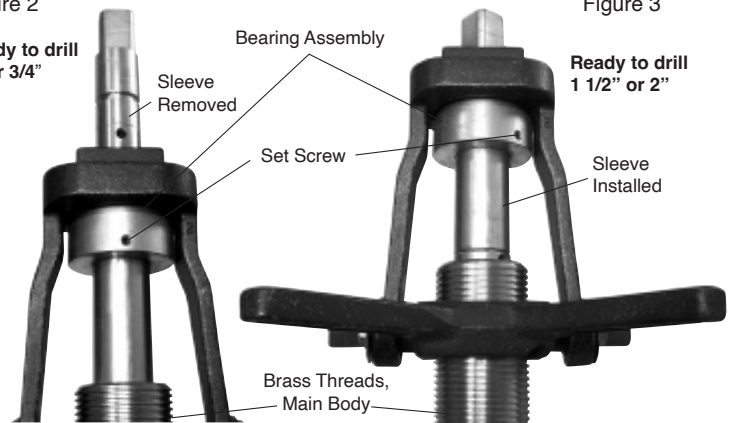
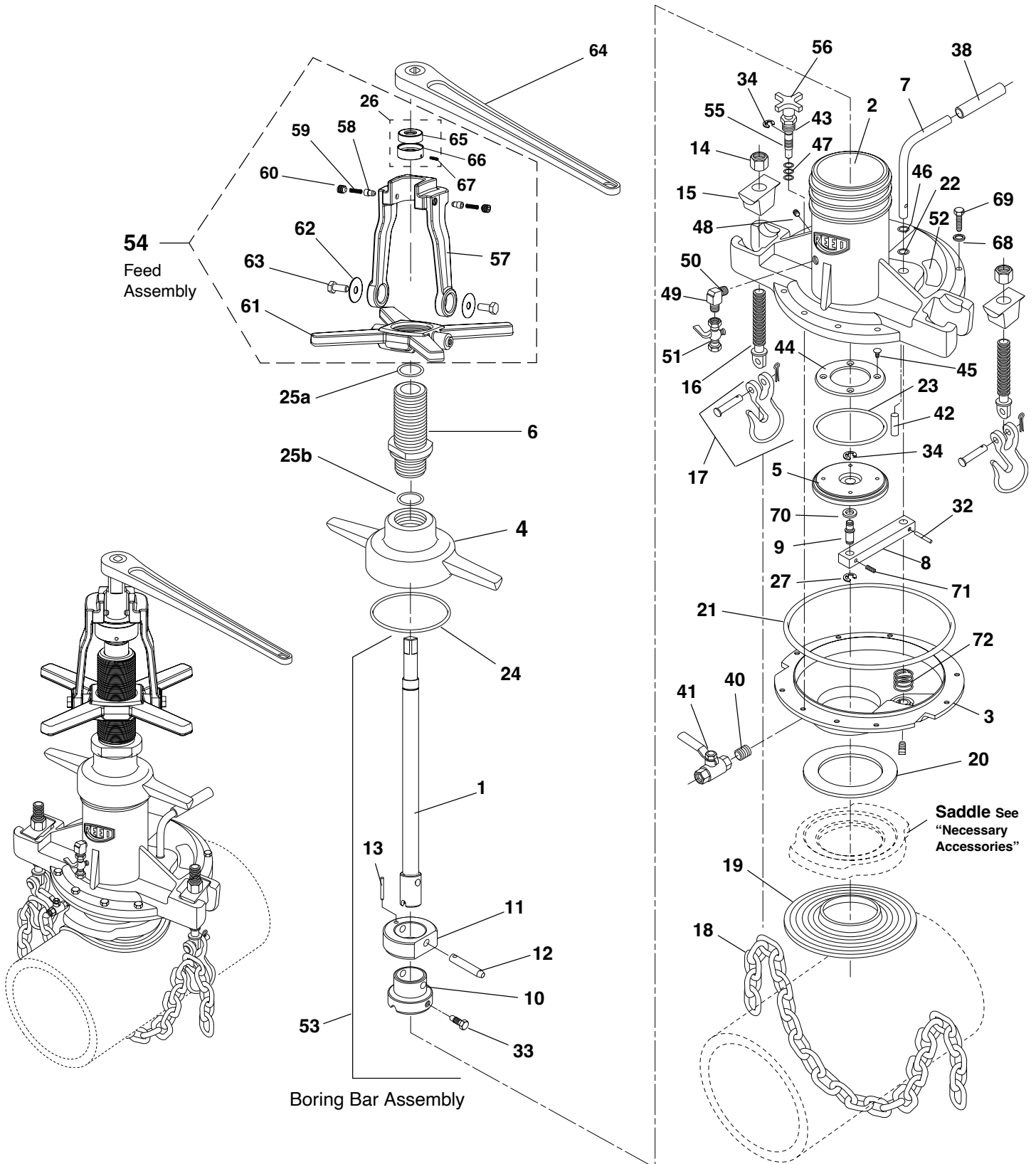

Figure 3

Ready to drill
1 1/2" or 2"

Sleeve Installed

TM1100 Tapping Parts Illustration, Parts List, and Necessary Accessories:



TM1100 Tapping Machine Parts List

Ref. No.	Description	REED Item Code	Ref. No.	Description	REED Item Code
1	Boring Bar	99302	*36	3/4" Insert Tool	98423
2	Top Chamber	98403	*37	1" Insert Tool	98424
3	Bottom Chamber	98404	38	Plastic Grip	40397
4	Top Chamber Cap	98405	*39	5/8" Combination Wrench	40405
5	Valve Poppet	98420	40	Brass Nipple	97564
6	Threaded Body	99300	41	Ball Valve	40396
7	Valve Lever	98406	42	Stop Pin	30130
8	Valve Poppet Bar	98407	43	Bushing	98429
9	Mini-Valve	98409	44	Poppet Ring	98419
10	Boring Bar Bearing	98410	45	Screw (4)	30199
11	Bearing Sleeve	98411	46	O-Ring - Valve Lever	40426
12	Knockout Pin	98412	47	O-Ring - Needle (3)	40425
13	Roll Pin	93436	48	Pipe Plug	40395
14	Nut	98421	49	Straight Elbow	40427
15	Swivel	98414	50	Close Nipple	40403
16	Chain Pull Rod	98415	51	Ball Valve	40273
17	Chain Hook	40369	52	Valve Sticker	50408
18	Hi Test Chain	98417	53	Boring Bar Assembly	99309**
19	Saddle Gasket	40372	54	Feed Assembly	99305
20	Saddle Ring Gasket	40371	55	Needle	98428
21	Bottom Chamber O-Ring	40373	56	Knob	40210
22	Valve Lever O-Ring	40374	57	Yoke	98495
23	Valve Poppet O-Ring	40375	58	Yoke Pin	98450
24	Top Cap Large Quad Ring	40376	59	Spring	94304
25	a. Threaded Body O-Ring	40378	60	Set Screw	38495
	b. Threaded Body O-Ring	40377	61	Star Feed	98494
26	Bearing Assembly	99307	62	Washer	39305
27	E-Ring	30116	63	Hex Bolt	30118
*28	a: Rolling Case	48474	64	Ratchet Wrench	40383
	b: TM1100 Foam Insert	48478	65	Bearing	40414
*29	Operator's Manual	59300	66	Bearing Retainer	99306
*30	Tapping Compound	98425	67	Set Screw	39306
*31	Wrench	02112	68	Lock Washer (10)	30177
32	Roll Pin	93435	69	Hex Nut Cap Screw (10)	30197
33	Tool Ret. Screw	98416	70	Rubber Washer	40382
34	E-Ring (2)	30009	71	Set Screw	30087
*35	Adapter Shank	98422	72	Comp Spring	40389

* Included but not shown

**99309 assembly includes: 99302, 98410, 98411, 98412, 93436, 98416.

TM1100 Necessary Accessories

P/N	Name	Item Code	P/N	Name	Item Code
1	Saddle 4"	98442	15	Saddle Gasket	40372
2	Saddle 6"	98439	16	Sealing Disc	40371
3	Saddle 8"	98440	17	Bearing Sleeve	98411
4	Saddle 10"	98441	18	Knockout Pin	98412
5	Saddle 12"	98438	19	13/16" Sq. Dr. Wrench	40383
6	Saddle 16"	98443	20	Power Drive Adapter	08430
7	Saddle 18"	98444	21	Drill Tap 3/4"	04390
8	Saddle 20"	98445	22	Drill Tap 1"	04391
9	Saddle 24"	98446	23	Drill Tap 3/4" — PVC	04396
10	Saddle 42"	98448	24	Drill Tap 1" — PVC	04397
11	Ext Chain 5' Lengths	98417	25	3/4" Corp Insertion Tool	98423
12	Chain Clevis 5/16"	40394	26	1" Corp Insertion Tool	98424
13	Tapping Compound 16 oz. can	98425	27	Adapter Shank	98422
14	Tapping Compound 6 oz. squeeze bottle	99140	28	User Manual	59300

Note: Extension chain and clevis to be used to extend TM1100 beyond basic 16" diameter capacity. Add one chain and clevis for up to 32" capacity. Add two chains and clevis for capacity up to 48".



REED Warranty

REED will repair or replace tools with any defects due to faulty materials or workmanship for one (1) year or five (5) years from the date of purchase, as applicable. This warranty does not cover part failure due to tool abuse, misuse, or damage caused where repairs or modifications have been made or attempted by non REED authorized repair technicians. This warranty applies only to REED tools and does not apply to accessories. This warranty applies exclusively to the original purchaser.

One (1) year warranty: Power units for pneumatic, electric, hydraulic and battery-powered tools have a one year warranty. This includes, but is not limited to REED pumps, universal pipe cutter motors, power drives, power bevel tools, threading machines, cordless batteries and chargers.

Five (5) year warranty: Any REED tool not specified under the one (1) year warranty above is warranted under the REED five (5) year warranty.

NO PARTY IS AUTHORIZED TO EXTEND ANY OTHER WARRANTY. NO WARRANTY FOR MERCHANTABILITY OR FITNESS FOR A PARTICULAR PURPOSE SHALL APPLY.

No warranty claims will be allowed unless the product in question is received freight prepaid at the REED factory. All warranty claims are limited to repair or replacement, at the option of REED, at no charge to the customer. REED is not liable for any damage of any sort, including incidental and consequential damages. This warranty gives you specific legal rights, and you may also have other rights which vary by state, province or country.

Warranty Effective December 1, 2018

Garantía REED

REED reparará o reemplazará las herramientas con cualquier defecto debido a defecto en materiales o mano de obra durante un (1) año o cinco (5) años a partir de la fecha de compra, según corresponda. Esta garantía no cubre las fallas de las piezas debido al abuso, mal uso o daños causados por reparaciones o modificaciones realizadas o intentadas por técnicos de reparación no autorizados por REED. Esta garantía se aplica solo a las herramientas REED y no se aplica a los accesorios. Esta garantía se aplica exclusivamente al comprador original.

Un (1) año de garantía: Las unidades de potencia para herramientas neumáticas, eléctricas, hidráulicas y alimentadas por baterías tienen una garantía de un año. Incluye, entre otras cosas, bombas REED, motores universales para cortatubos, motopropulsores, herramientas de biselado, máquinas roscadoras, baterías inalámbricas y cargadores.

Cinco (5) años de garantía: Cualquier herramienta REED que no esté especificada bajo la garantía de un (1) año ya mencionada cuenta con la garantía de cinco (5) años de REED.

NINGUNA DE LAS PARTES ESTÁ AUTORIZADA A EXTENDER NINGUNA OTRA GARANTÍA. NO SE APLICARÁ NINGUNA GARANTÍA DE COMERCIABILIDAD O IDONEIDAD PARA UN PROPÓSITO PARTICULAR.

No se permitirán reclamos de garantía a menos que el producto en cuestión se reciba en la fábrica de REED con el flete pagado por adelantado. Todos los reclamos de garantía se limitan a la reparación o reemplazo, a elección de REED, sin costo alguno para el cliente. REED no es responsable de ningún daño de ningún tipo, incluyendo daños incidentales y emergentes. Esta garantía le otorga derechos legales específicos y también puede tener otros derechos que varían según el estado, la provincia o el país.

Garantía efectiva a partir del 1 de diciembre de 2018



VIDEO TRAINING



TM100



VIDEO DE CAPACITACIÓN



TM100

See "Packing the Kit" on page 5.