

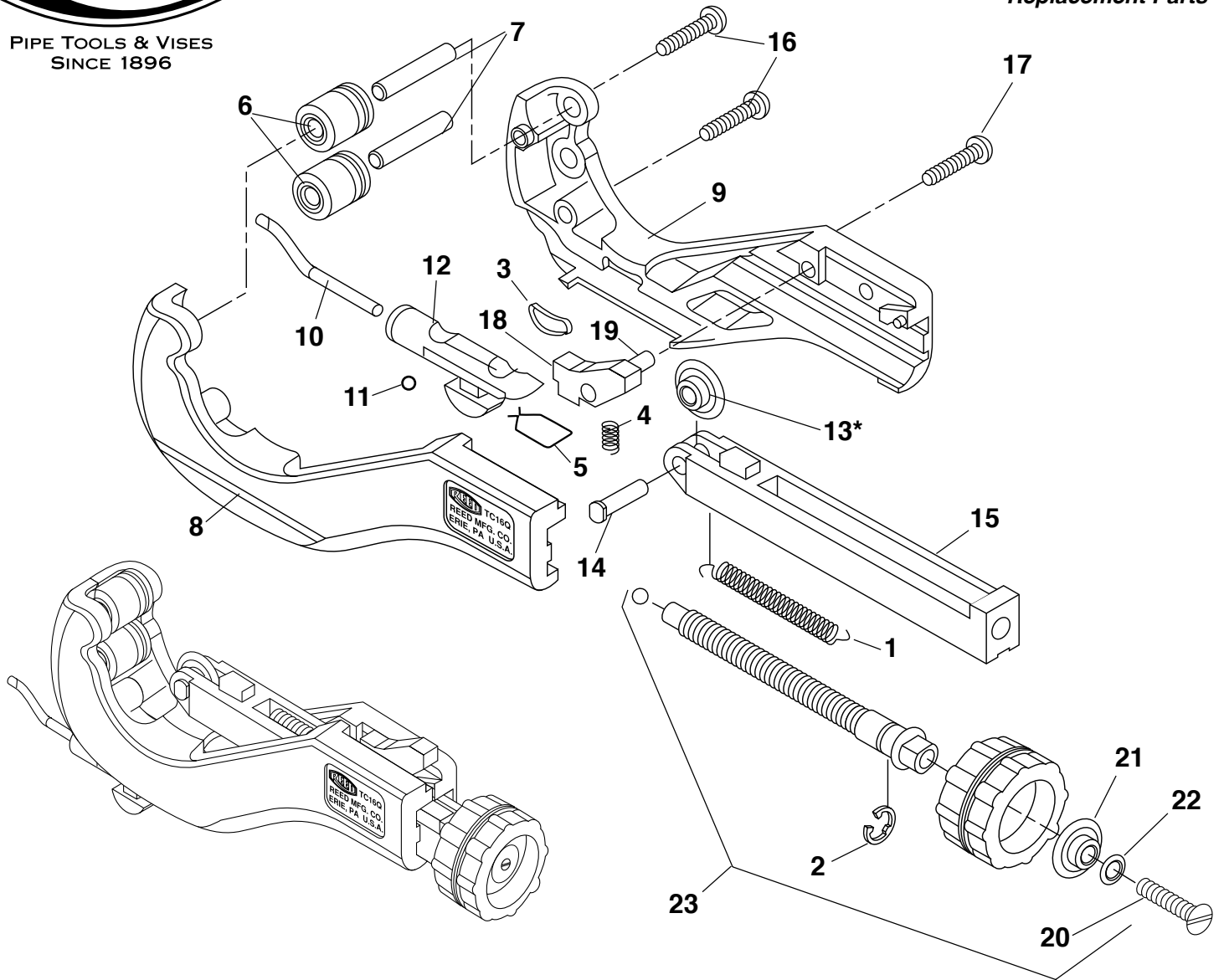

PIPE TOOLS & VISES
SINCE 1896

Quick Release™ Tubing Cutters (TC1.6Q models)

Replacement Parts



Parts List

Ref. No.	Description	Item Code	Qty. Used	Ref. No.	Description	Item Code	Qty. Used
1	Bar Spring	93630	1	13*	Cutter Wheel for Copper	03660	1
2	Retaining Ring	93433	1		Cutter Wheel For CSST	03659	1
3	Flat Spring	40440	1		Cutter Wheel For Plastic	04180	1
4	Zip Nut Spring	93440	1		Cutter Wheel For PVC	04184	1
5	Blade Retaining Spring	40437	1	14	Wheel Pin	93427	1
6	Roller	93628	2	15	Bar	93623	1
7	Roller P.J.	40438	2	16	Assembly Screw/Nut End	30222	2
8	Left Body Half	93621	1	17	Assembly Screw/Roller End	30221	1
9	Right Body Half	93622	1	18	Feed Nut	93407	1
10	Burr Blade / Reamer	94437	1	19	Nut Pin	40439	1
11	Steel Ball	93447	1	20	Screw	93449	1
12	Reamer Holder	93625	1	21	Extra Cutter Wheel	—	1
				22	Washer	93434	1
				23	Knob & Screw Assembly	93635	1

Reed Manufacturing Company
1425 West 8th Street
Erie, PA 16502 USA



Phone: 800-666-3691 or 814-452-3691
Fax: 800-456-1697 or 814-455-1697
www.reedmfgco.com

RP-1219-35